

BI2-EG08-AP6X-H1341/S1589

Inductive Sensor – With Weldguard® coating

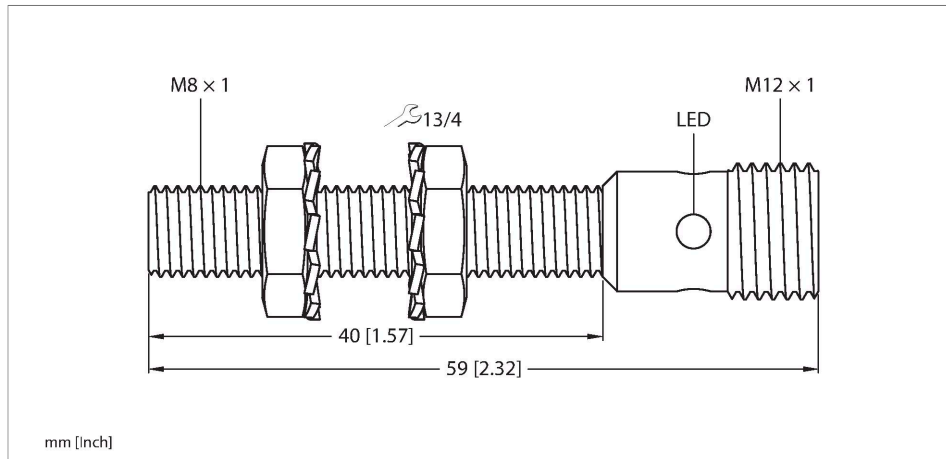

Technical data

| | |
|--|---|
| Type | BI2-EG08-AP6X-H1341/S1589 |
| ID | 4602086 |
| Special version | S1589 Corresponds to: With weldguard coating |
| General data | |
| Rated switching distance | 2 mm |
| Mounting conditions | Flush |
| Secured operating distance | $\leq (0.81 \times S_n)$ mm |
| Correction factors | St37 = 1; Al = 0.3; stainless steel = 0.7; Ms = 0.4 |
| Repeat accuracy | $\leq 2\%$ of full scale |
| Hysteresis | 20 % |
| Electrical data | |
| Operating voltage U_B | 10...30 VDC |
| Ripple U_{ss} | $\leq 10\%$ U_{Bmax} |
| DC rated operating current I_e | ≤ 150 mA |
| No-load current | ≤ 15 mA |
| Residual current | ≤ 0.1 mA |
| Isolation test voltage | 0.5 kV |
| Short-circuit protection | yes/Cyclic |
| Voltage drop at I_e | ≤ 1.8 V |
| Wire break/reverse polarity protection | yes/Complete |
| Output function | 3-wire, NO contact, PNP |
| Switching frequency | 3 kHz |

Features

- M8 × 1 threaded barrel
- Stainless steel, 1.4305 (AISI 303)
- Large sensing range
- DC 3-wire, 10...30 VDC
- NO contact, PNP output
- M12 x 1 male connector

Wiring diagram

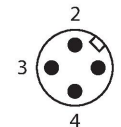
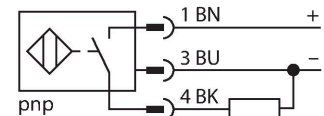

Functional principle

Inductive sensors detect metal objects contactless and wear-free. For this purpose they use a high-frequency electromagnetic AC field that interacts with the target. The sensors hosting a ferrite core coil generate the AC field through an LC resonant circuit.

Technical data

| Mechanical data | |
|---------------------------------------|--|
| Design | Threaded barrel, M8 x 1 |
| Dimensions | 59 mm |
| Housing material | Stainless steel, 1.4305 (AISI 303) |
| Active area material | Plastic, PA6.6 |
| Max. tightening torque of housing nut | 5 Nm |
| Electrical connection | Connector, M12 x 1 |
| Environmental conditions | |
| Ambient temperature | -25...+70 °C |
| Vibration resistance | 55 Hz (1 mm) |
| Shock resistance | 30 g (11 ms) |
| Protection class | IP67 |
| MTTF | 2283 years acc. to SN 29500 (Ed. 99) 40 °C |
| Switching state | LED, Yellow |

Mounting instructions

Mounting instructions/Description



| | |
|------------------------|---------|
| Distance D | 2 x B |
| Distance W | 3 x Sn |
| Distance T | 3 x B |
| Distance S | 1.5 x B |
| Distance G | 6 x Sn |
| Diameter active area B | Ø 8 mm |

Accessories

QM-08

6945100

Quick-mount bracket with dead-stop, chrome-plated brass, male thread M12 x 1. Note: The switching distance of proximity switches may be reduced through the use of quick-mount brackets.

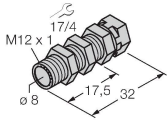

BST-08B

6947210

Mounting clamp for threaded barrel sensors, with dead-stop; material: PA6

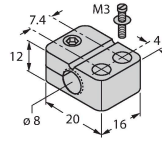

MW08

6945008

Mounting bracket for threaded barrel sensors; material: Stainless steel A2 1.4301 (AISI 304)

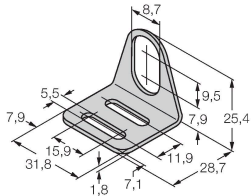

BSS-08

6901322

Mounting clamp for smooth and threaded barrel sensors; material: Polypropylene

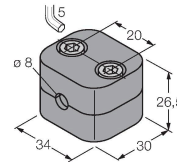

MBS80

69479

Mounting clamp for smooth barrel sensors; mounting block material: Anodized aluminum

